



EBV Variable Frequency Circulation Pump



Operating Condition

1. Apply to heating system
2. Max. system pressure: 10bar
3. Operation condition: Ambient Temperature: 0°C~40°C Ambient Humidity: 95% Liquid Temperature: -10°C~110°C
Ambient temperature must be lower than liquid temperature, in order to avoid condensate water produced in the interior of stator.
4. Liquid: Clean, non-corrosive and non-explosive liquids, without any particle, fiber or mineral oil.
Water/glycol mixtures max. mixing ratio: 1:1
5. Dry running no more than 10min.

Model Definition

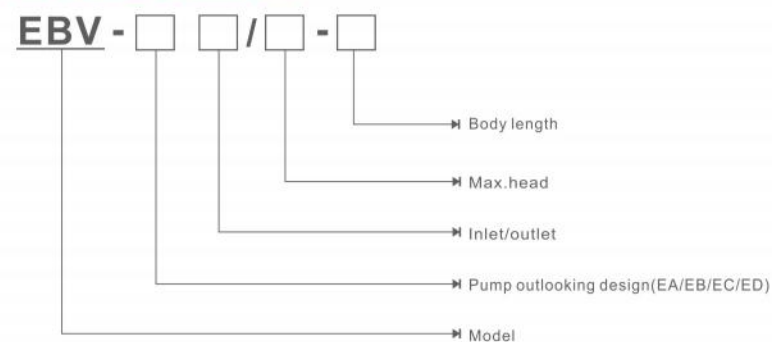

• Example: EBV-EA 25/6 is small circulation pump with cast-iron body, 25inlet/outlet, 6m head, 180mm body length

Setting	Pump curve	Function
PP1	Lowest proportional-pressure curve	The duty point of the pump will move up or down on the lowest proportional-pressure curve, depending on heating demand. The head (pressure is reduced at falling heating demand and increased at rising heating demand)
PP2	Highest proportional-Pressure curve	The duty point of the pump will move up or down on the highest proportional-pressure curve, depending on heating demand. The head (pressure is reduced at falling heating demand and increased at rising heating demand)
CP1	Lowest constant-Pressure curve	The duty point of the pump will move out or in constant-pressure curve, depending on the heating demand. The head (pressure) is kept constant, irrespective of the heating demand.
CP2	Highest constant-Pressure curve	The duty point of the pump will move out or in constant-pressure curve, depending on the heating demand. The head (pressure) is kept constant, irrespective of the heating demand.
III	Speed III	Pump runs at a constant speed and consequently on a constant curve. In speed III, the pump is set to run on the Max. curve under all operating conditions. Quick venting of the pump can be obtained by setting the pump to speed III for a short period.
II	Speed II	Pump runs at a constant speed and consequently on a constant curve. In speed II, the pump is set to run on the Medium curve under all operating conditions.
I	Speed I	Pump runs at a constant speed and consequently on a constant curve. In speed I, the pump is set to run on the Min. curve under all operating conditions.
AUTO (EX-factory Setting)		Under "AUTO" mode, the power of pump automatically be up or down according to flow of system in certain condition.
night mode		Pump runs select to night mode, after one hour the power automatically down, after two hours, it will be down lowest between 5-10watt, after seven hours, the pump auto mode eliminate and recovery to original condition.

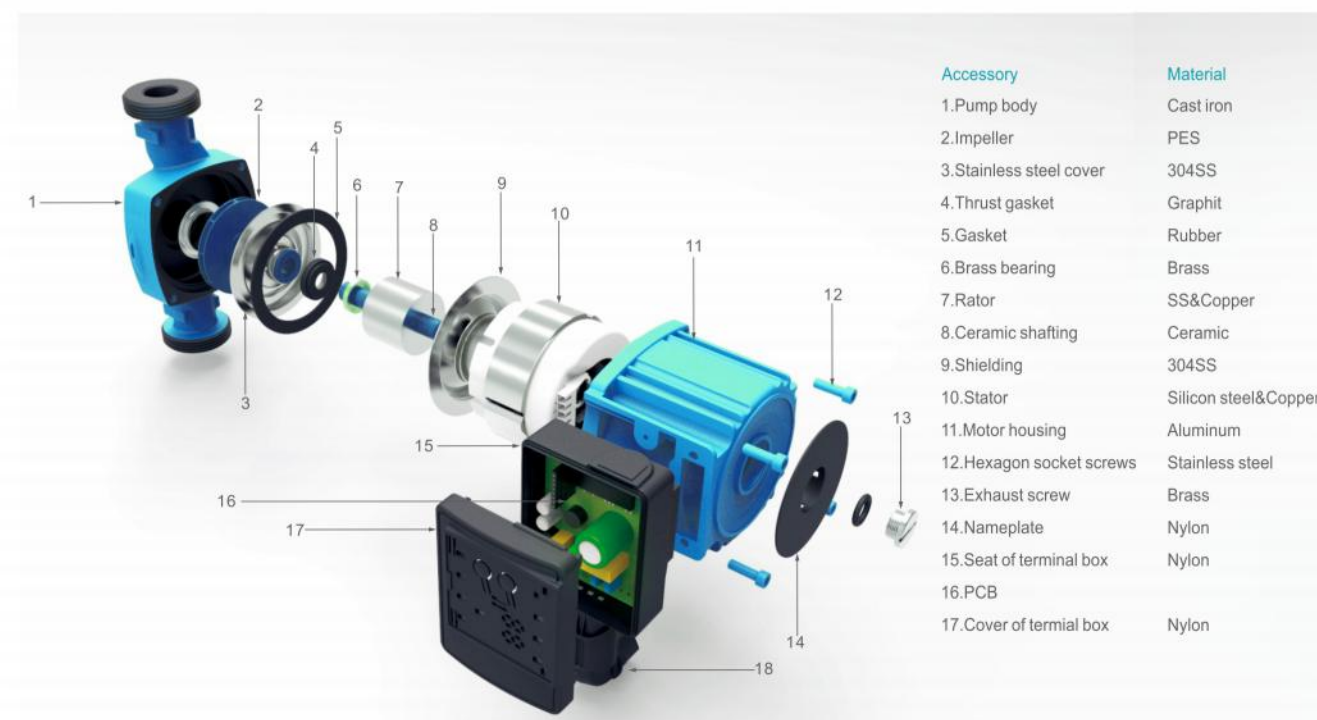



Performance Table

Model	Power (W)	Max. flow (m³/h)	Max. head (m)	Voltage (V)	Material of pump body				Dimension(mm)							Weight (Kg)	
					Cast Iron	Plastic	Brass	Stainless steel	L1		L2	B1	B2	H1	H2		G
EBV-EA 15/4	5~22	1.8	4	220/50	●		●	●	●	●	80	155	105	129	101	1"	2.1
EBV-EA 25/4		2.6			●	●	●	●	●	80	155	105	129	101	1 1/2"	2.3	
EBV-EA 32/4		3			●		●	●	●	80	155	105	129	101	2"	2.4	
EBV-EA 15/5	5~32	2.3	5		●		●	●	●	●	80	155	105	129	101	1"	2.1
EBV-EA 25/5		3.1			●	●	●	●	80	155	105	129	101	1 1/2"	2.3		
EBV-EA 32/5		3.4			●		●	●	●	80	155	105	129	101	2"	2.4	
EBV-EA 15/6	5~45	2.4	6		●		●	●	●	●	80	155	105	129	101	1"	2.1
EBV-EA 25/6		3.6			●	●	●	●	80	155	105	129	101	1 1/2"	2.3		
EBV-EA 32/6		3.6			●		●	●	●	80	155	105	129	101	2"	2.4	
EBV-EA 15/7	5~47	2.7	7		●		●	●	●	●	80	155	105	129	101	1"	2.1
EBV-EA 25/7		3.7			●	●	●	●	80	155	105	129	101	1 1/2"	2.3		
EBV-EA 32/7		3.7			●		●	●	●	80	155	105	129	101	2"	2.4	

EBV15/4

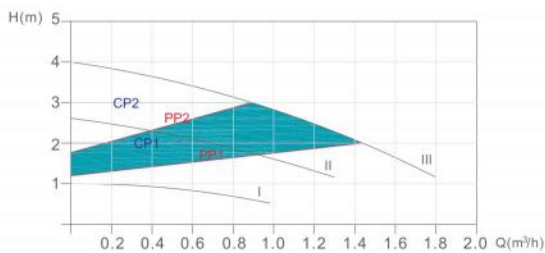

EBV15/5

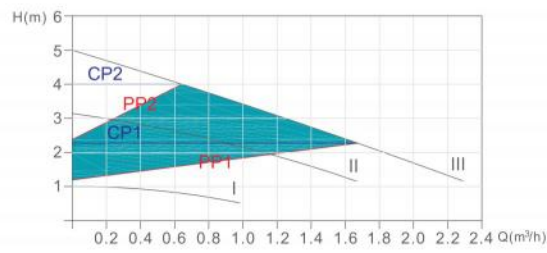

EBV15/6

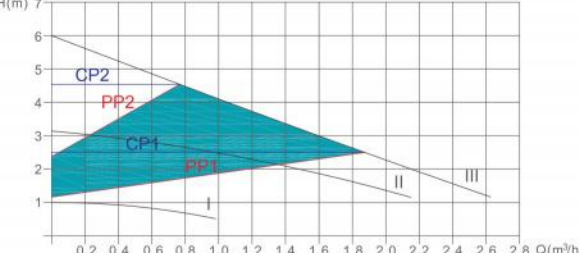

EBV15/7

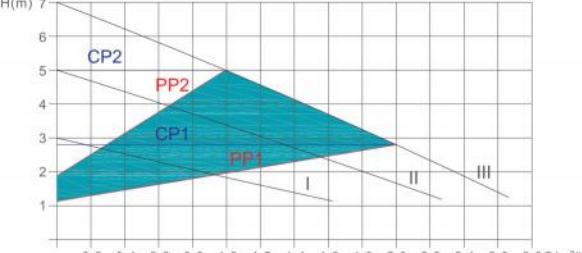

EBV25/4

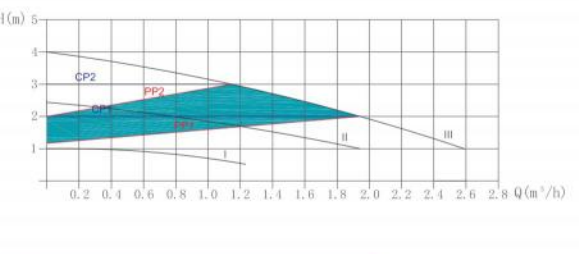

EBV25/5

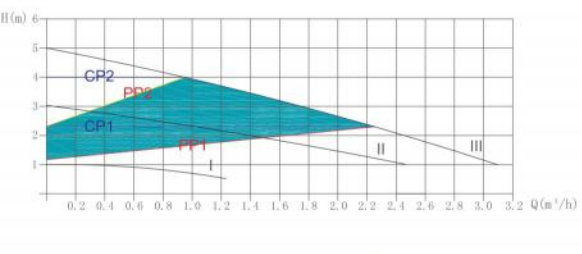

EBV25/6

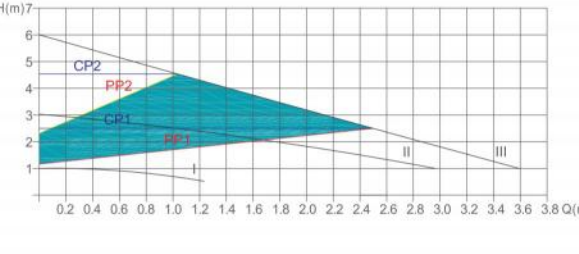

EBV25/7

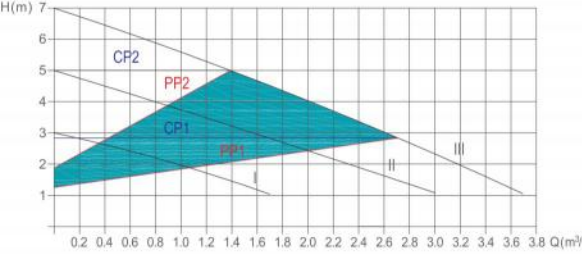

EBV32/4

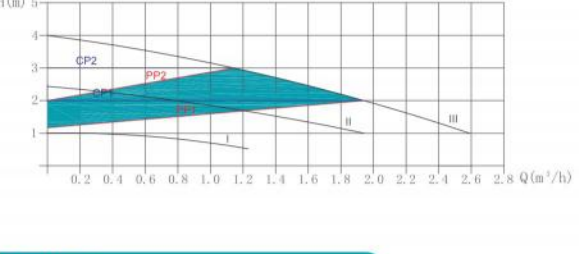

EBV32/5

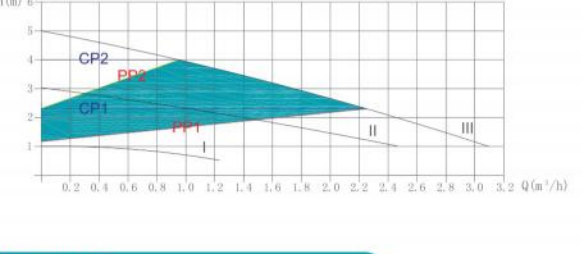

EBV32/6

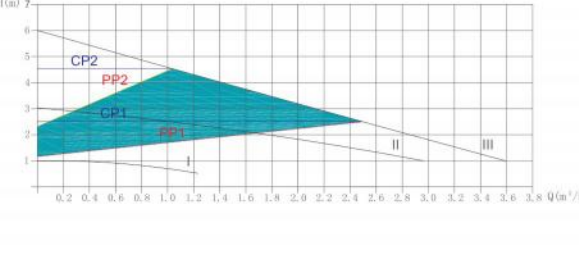

EBV32/7

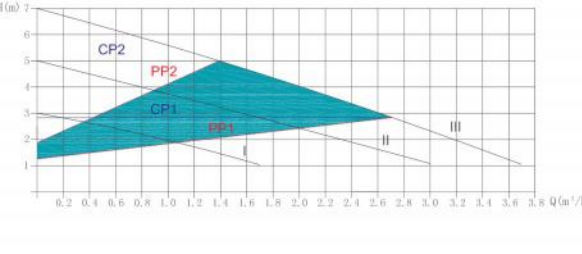

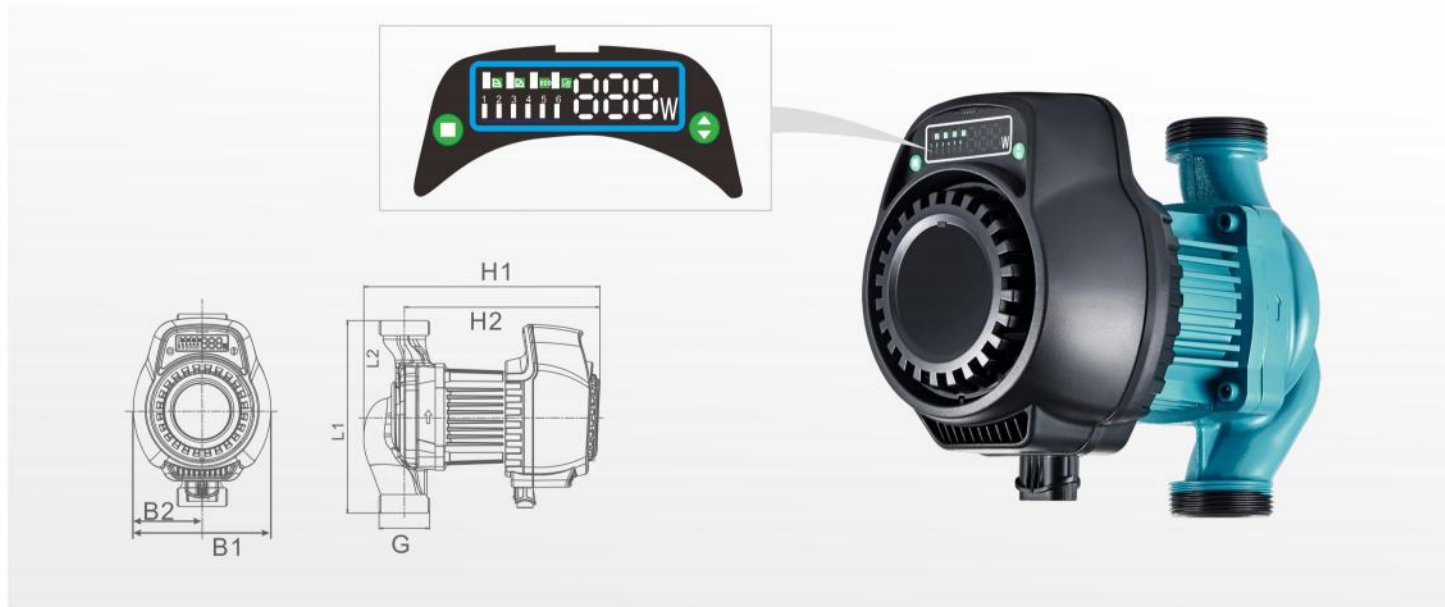

EBV-EB 25/8

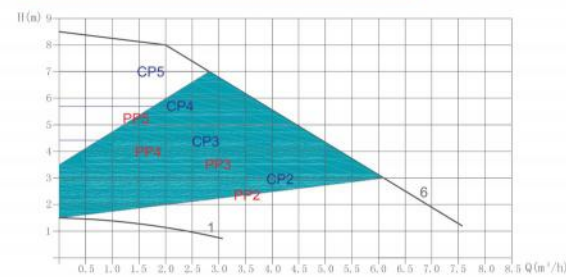

EBV-EB 32/8

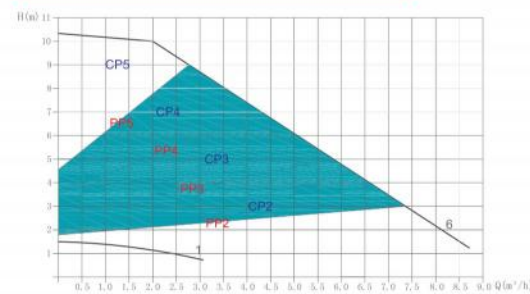

EBV-EB 25/10

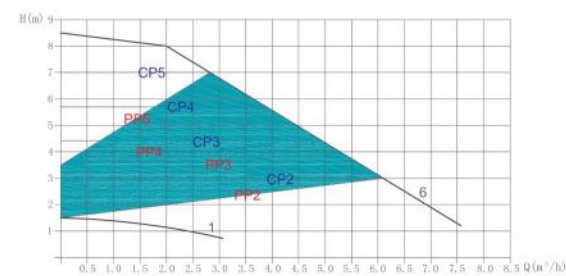

EBV-EB 32/10

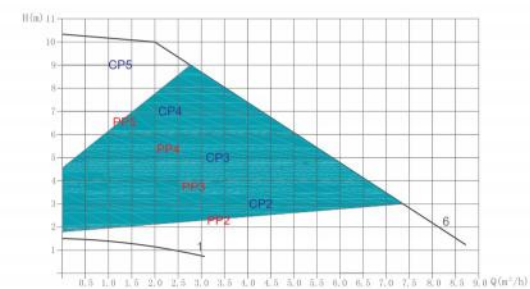

Performance Table

Model	Power (W)	Max. flow (m³/h)	Max. head (m)	Voltage (V)	Mater of pump body				Dimension(mm)							Weight(Kg)
					Cast Iron	Plastic	Brass	Stainless steel	L1	L2	B1	B2	H1	H2	G	
EBV-EB 25/8	10~130	7.6	8	220/50	●			●	180	90	129	64.5	236	184	1 1/2"	3.3
EBV-EB 32/8		7.8							180	90	129	64.5	236	184	2"	3.4
EBV-EB 25/10	8.6	10	180						90	129	64.5	236	184	1 1/2"	3.3	
EBV-EB 32/10	8.8		180						90	129	64.5	236	184	2"	3.4	

Pos.	Icon	Description
1		Light in Constant Pressure
2		Light in Proportional Pressure
3		ECO mode
4		Light in Air-Vent (Press Setting Button for 5~6 seconds)
5		Power Light
6		Button for change of control mode (The button is used for change the pumps modes, for example: from constant pressure to proportional pressure, or to ECO mode, also can for Air-venting mode.)
7		Light for each speeds (The 6 lights are shown the different working conditions. Only under two modes(constant pressure and proportional pressure, these lights can be chosen.)
8		Button for setting (This button is used for setting the different speeds(light in 1,2,3,4,5,6) for two modes. Using this button, we can chose the speeds from Max.to Min..)

Conrol Panel Pump Curve	Description
 CP2,CP3,CP4,CP5	The operating point moves back and forth on the curve according to the volume of flow from the system. As shown in the graph, the pump pressure remains constant, not affected by the volume demands of flow.
 CP1--Min. Speed CP6--Max.Speed	The two speeds are the Min. and Max. ones under constant pressure, the curve shown as in graph. can not keep constant. It rises and goes down as manual operation.
 PP2,PP3,PP4,PP5	The operating point moves back and forth on the proportional pressure curve according to the volume of flow from system. As shown in the graph. the pump pressure is directly proportional to the flow demands.
 CP1--Min. Speed CP6--Max.Speed	The two speeds are the Min. and Max. ones under proportional pressure, the curve shown as in graph. can not keep constant. It rises and goes down as manual operation.
 ECO	This mode use working as "auto adaptation". It confines the performance of the pumps in aimed scope. As shown in graph: 1.Performance can be adjusted according to the scale of system 2.Performance can be adjusted according to the changing of load during a specific period. Under the mode of "ECO", the pump is controlled by means of proportional pressure



Feature

Shielding pump, variable frequency adaptive, quiet and efficient

Material

- Pump body: Cast iron
- Impeller: PES
- Bearing: Ceramic
- Shaft: Ceramic
- Motor: International class H high temperature copper wire

Application

Air conditioning, refrigeration secondary system
Combined heating and circulation

Operating Interface

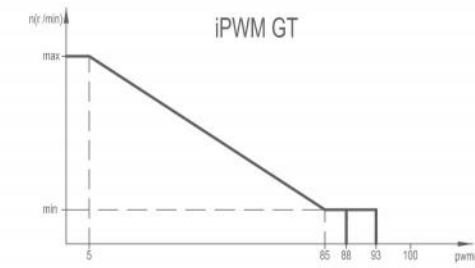

PWM sign input(%)
 <5: Pump runs at max speed
 5-85: Pump linear runs from max to min
 85-93: Pump runs at min speed (running)
 85-88: Pump runs at min speed (start)
 93-100: Pump stop



PWM sign input(%)
 <5: Pump stop
 7-15: Pump runs at min speed (running)
 12-15: Pump runs at min speed (start)
 15-90: Pump linear runs from min to max
 >95: Pump runs at max speed

• The PWM could be customized for real application

Performance Table

Model	Power	Max. flow	Max. head	Voltage	Body length		G
	(W)	(m ³ /h)	(m)		130	180	
EBV-EC 15/4-130	5-22	2.2	4	220/50	●		1"
EBV-EC 25/4-130		2.8			●	1 1/2"	
EBV-EC 25/4-180		3				●	1 1/2"
EBV-EC 32/4-180		3				●	2"
EBV-EC 15/5-130	5-32	2.6	5		●		1"
EBV-EC 25/5-130		3.2			●	1 1/2"	
EBV-EC 25/5-180		3.6				●	1 1/2"
EBV-EC 32/5-180		3.6				●	2"
EBV-EC 15/6-130	5-45	3	6		●		1"
EBV-EC 25/6-130		3.6			●	1 1/2"	
EBV-EC 25/6-180		4				●	1 1/2"
EBV-EC 32/6-180		4				●	2"
EBV-EC 15/7-130	5-52	3.6	7	●		1"	
EBV-EC 25/7-130		3.8		●	1 1/2"		
EBV-EC 25/7-180		4.2			●	1 1/2"	
EBV-EC 32/7-180		4.2			●	2"	
EBV-EC 15/8-130	5-52	3.6	8	●		1"	
EBV-EC 25/8-130		3.8		●	1 1/2"		
EBV-EC 25/8-180		4.2			●	1 1/2"	
EBV-EC 32/8-180		4.2			●	2"	

EBV-EC 15/4-130

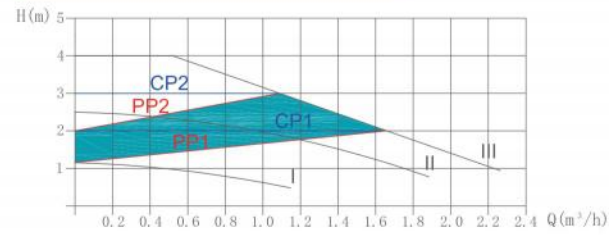

EBV-EC 25/4-130

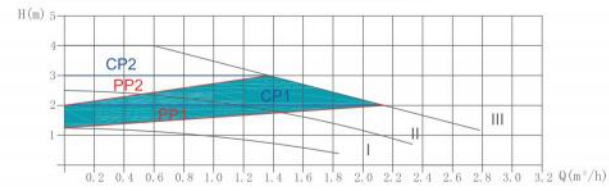

EBV-EC 25/4-180

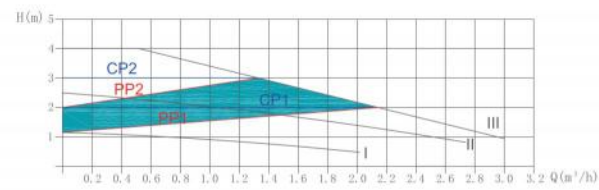

EBV-EC 32/4-180

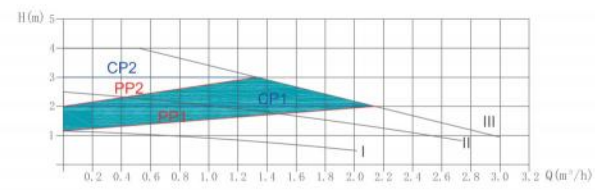

EBV-EC 15/5-130

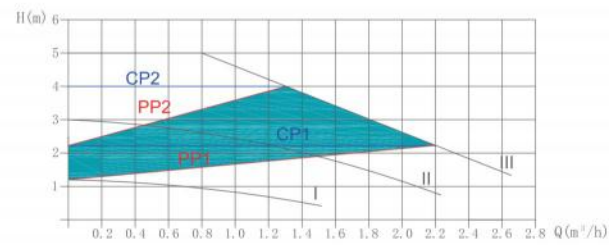

EBV-EC 25/5-130

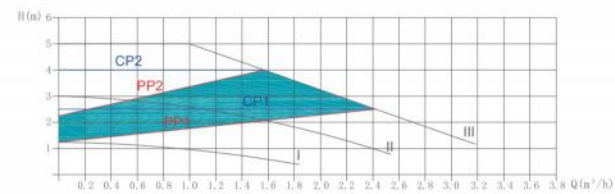

EBV-EC 25/5-180

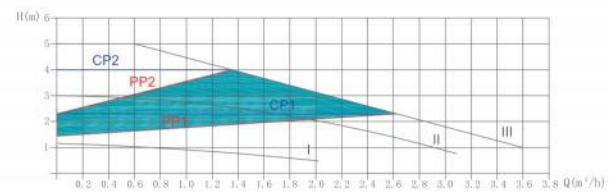

EBV-EC 32/5-180

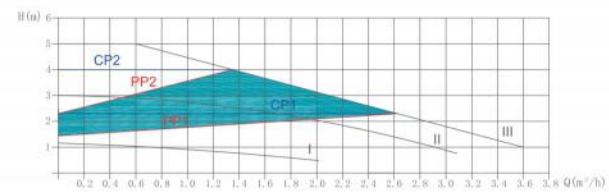

EBV-EC 15/6-130

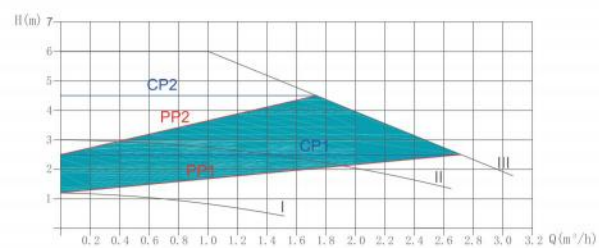

EBV-EC 25/6-130

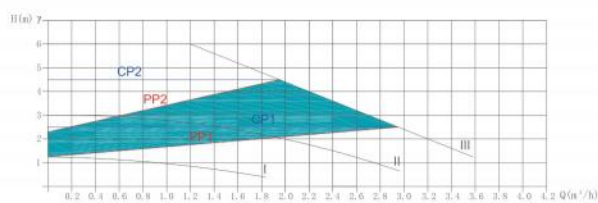

EBV-EC 25/6-180

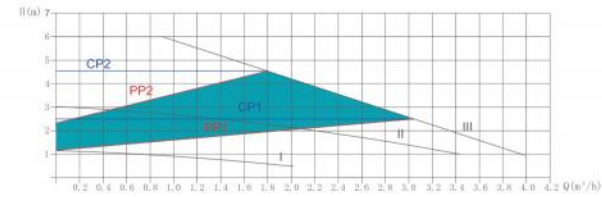

EBV-EC 32/6-180

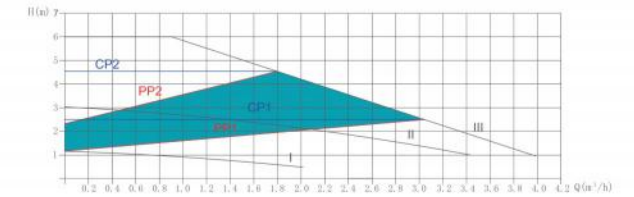

EBV-EC 15/7-130

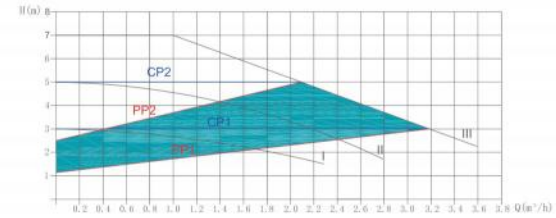

EBV-EC 25/7-130

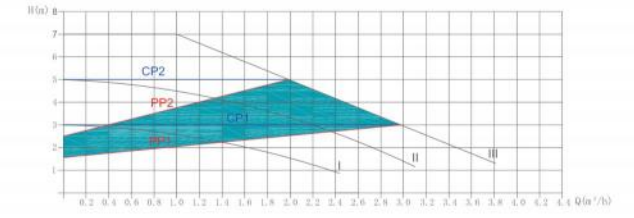

EBV-EC 25/7-180

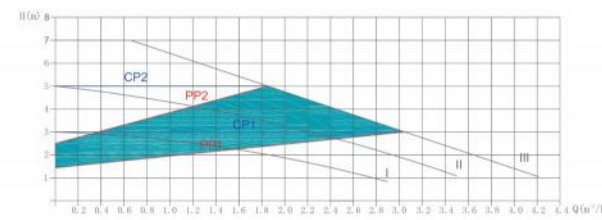

EBV-EC 32/7-180

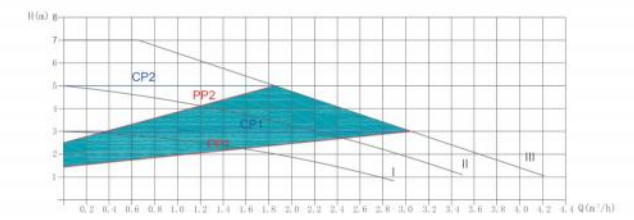

EBV-EC 15/8-130

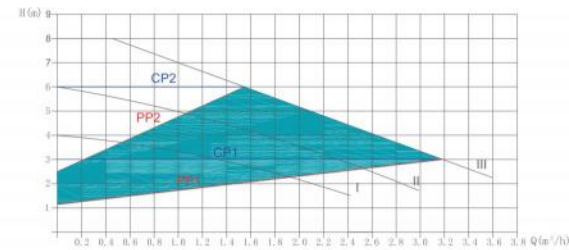

EBV-EC 25/8-130

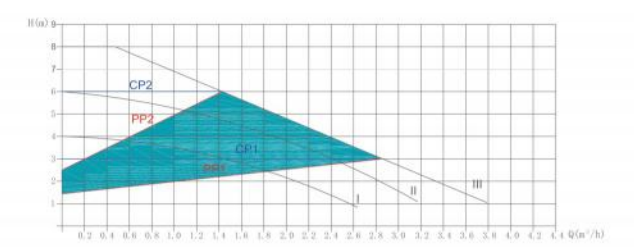

EBV-EC 25/8-180

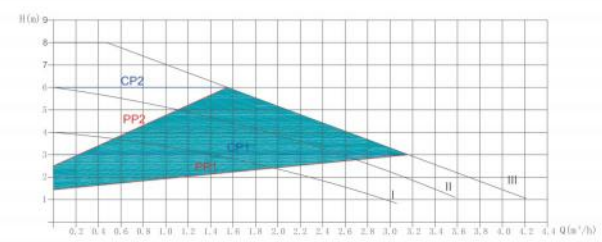



Feature

- Motor with BMC craft.
- PCB be potted with Polyurethane
- The pump body is made of stainless steel precision casting
- Touching buttons
- Lot (The Internet of Things) connection
- Shielding pump, variable frequency adaptive, quiet and efficient

Material

- Pump body: Cast iron
- Impeller: PES
- Bearing: Ceramic
- Shaft: Ceramic
- Motor: International class H high temperature copper wire

Application

- Air conditioning, refrigeration secondary system
- Combined heating and circulation

PWM performance



- PWM signal input (%)
- <5: Pump runs at max. speed
 - 5-85: Pump linear runs from max to min
 - 85-93: Pump runs at minimum speed. (running)
 - 85-88: Pump runs at minimum speed. (start)
 - 93-100: Pump stop

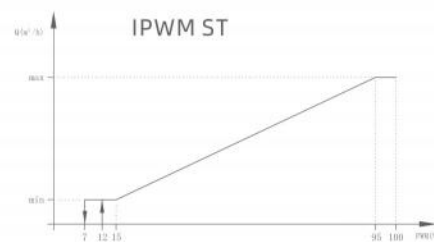

- PWM signal input (%)
- 0-7: Pump stop
 - 7-15: Pump runs at minimum speed. (running)
 - 12-15: Pump runs at minimum speed. (start)
 - 15-95: Pump linear runs from min. to max.
 - >95: Pump runs at max. speed



- PWM signal output (%)
- 0-60: power 0-100% (slope 1.67% power/ 1.00% PWM)
 - 75: Other alarm
 - 85: Motor alarm (short circuit, over current)
 - 90: Block alarm
 - 95: Motor stop (PWM control)

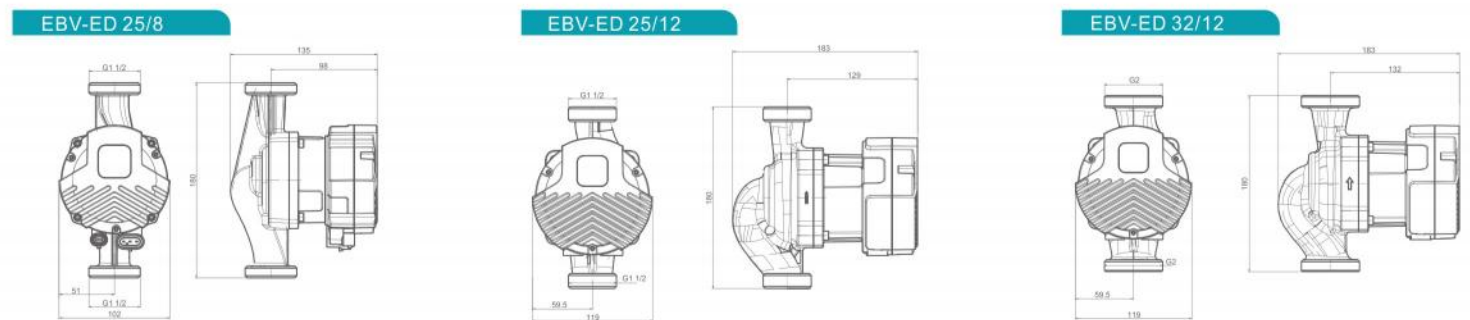

Performance Table

Model	Power	Max. flow	Max. head	Voltage	Material of pump body			Body length		G			
	(W)	(m³/h)	(m)		220V/50Hz	Cast iron	Brass	Stainless steel	130		180		
EBV-ED 25/8	80	12	8	●	●	●	●	●	●	1 1/2"			
EBV-ED 25/10	180	8.6	8					●	●		●	●	●
EBV-ED 25/12	220	9.5	12					●	●		●	●	●
EBV-ED 25/15	280	12	15					●	●		●	●	●
EBV-ED 25/18	360	11	18					●	●		●	●	●
EBV-ED 32/10	180	8.7	8					●	●		●	●	●
EBV-ED 32/12	220	9.5	12	●	●	●	●	●					
EBV-ED 32/15	280	10.2	15	●	●	●	●	●					
EBV-ED 32/18	360	11	18	●	●	●	●	●					

